



ISO-BSP FITTINGS
PVC-C

TemperFIP100® adapter fittings

FITTINGS

ISO-BSP

Series of fittings designed for conveying fluids under pressure with threaded and cold chemical solvent weld jointing systems (solvent welding) using suitable solvent cement (TemperGLUE WELD-ON) and cleaner-primer.

ADAPTOR FITTINGS

Technical specifications	
Size range	d 16 ÷ 63 (mm); R 3/8" ÷ 2"
Nominal pressure	PN 16 with water at 20° C
Temperature range	0 °C ÷ 100 °C
Coupling standards	Solvent welding: EN ISO 15493 Can be coupled to pipes according to EN ISO 15493 Thread: ISO 228-1, DIN 2999
Reference standards	Construction criteria: EN ISO 15493 Test methods and requirements: EN ISO 15493 Installation criteria: DVS 2204, DVS 2221, UNI 11242
Fitting material	PVC-C
Seal material	EPDM, FPM

TECHNICAL DATA

REGRESSION CURVE FOR PVC-C FITTINGS

Regression coefficients in accordance with standard EN ISO 15493 for minimum MRS = 20 N/mm² (MPa).

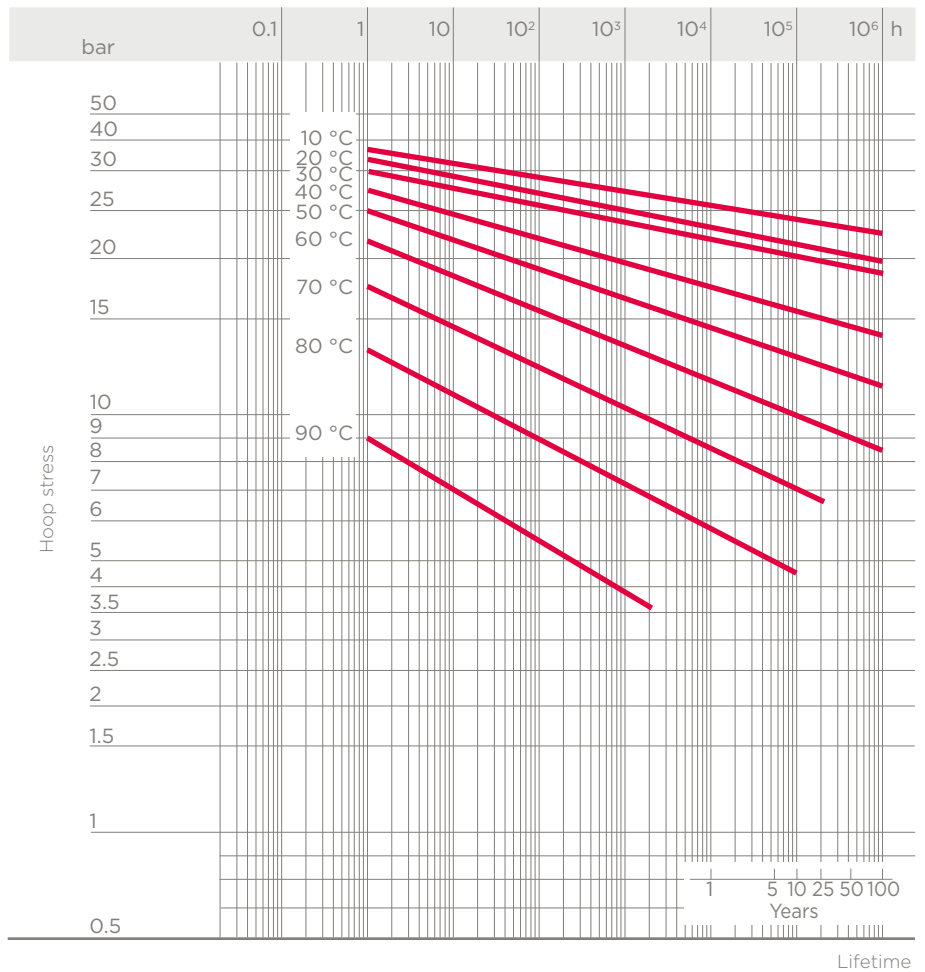

PRESSURE VARIATION ACCORDING TO TEMPERATURE

For water and non-hazardous fluids for which the material is classified as CHEMICALLY RESISTANT (life expectancy 25 years). In other cases, a reduction of the nominal pressure PN is required.

Note

When using PVC-C at working temperatures higher than 90°, it is advisable to first contact the service centre.

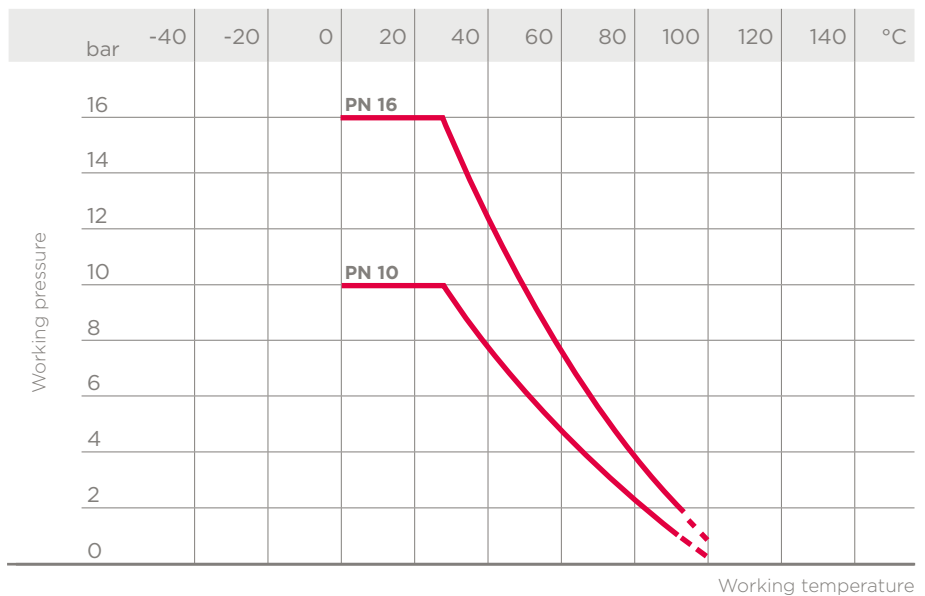

The information in this leaflet is provided in good faith. No liability will be accepted concerning technical data that is not directly covered by recognised international standards. FIP reserves the right to carry out any modification. Products must be installed and maintained by qualified personnel.

DIMENSIONS

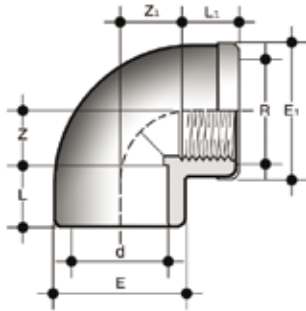

GIMC

90° elbow with reinforced solvent weld socket d and BSP threaded female end R with STAINLESS steel reinforcing ring

d x R	PN	E	E ₁	L	L ₁	Z	Z ₁	g	Code
16 x 3/8"	16	23.5	24.5	14	11.4	10	13	22	GIMC016038
20 x 1/2"	16	28.5	29.5	16	15	12	13	33	GIMC020012
25 x 3/4"	16	35	36	19	16.3	14	17	53	GIMC025034
32 x 1"	16	43	44	22	19.1	18	20.5	94	GIMC032100
40 x 1" 1/4	16	50	51	26	21.4	22	27	104	GIMC040114
50 x 1" 1/2	16	61	62	31	21.4	27	37	203	GIMC050112
63 x 2"	16	76	77	38	25.7	33	46	380	GIMC063200

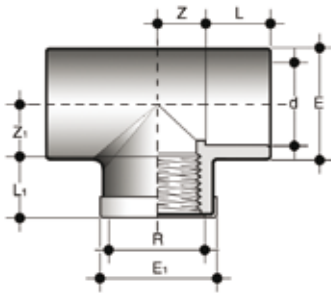

TIMC

90° Tee with reinforced solvent weld socket d and BSP threaded female end R with STAINLESS steel reinforcing ring

d x R	PN	E	E ₁	L	L ₁	Z	Z ₁	g	Code
16 x 3/8"	16	23.5	24.5	14	11.4	9	11	25	TIMC016038
20 x 1/2"	16	28.5	29.5	16	15	12	13	40	TIMC020012
25 x 3/4"	16	35	36	19	16.3	15	17	63	TIMC025034
32 x 1"	16	43	44	22	19.1	18	21	118	TIMC032100
40 x 1" 1/4	16	50	51	26	21.4	21.5	27	137	TIMC040114
50 x 1" 1/2	16	61	62	31	21.4	27	37	231	TIMC050112
63 x 2"	16	76	77	38	25.7	33.5	46	457	TIMC063200

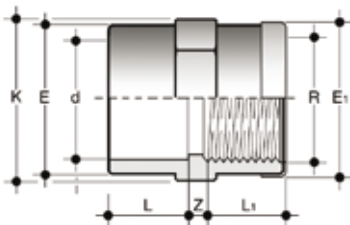

MIMC

Double socket with solvent weld socket d and BSP threaded female end r with STAINLESS steel reinforcing ring

d x R	PN	E	E ₁	K	L	L ₁	Z	g	Code
16 x 3/8"	16	23.5	24.5	24	14	11.4	5.6	15	MIMC016038
20 x 1/2"	16	28.5	29.5	29	16	15	4	25	MIMC020012
25 x 3/4"	16	35	36	35	19	16.3	5	38	MIMC025034
32 x 1"	16	43	44	43	22	19.1	6	58	MIMC032100
40 x 1" 1/4	16	50	51	50	26	21.4	5	66	MIMC040114
50 x 1" 1/2	16	61	62	61	31	21.4	8	109	MIMC050112
63 x 2"	16	76	77	76	38	25.7	7.5	196	MIMC063200

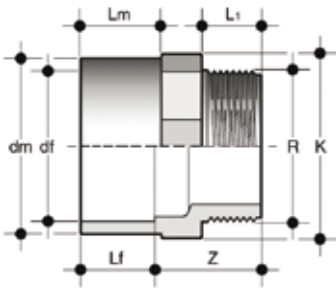

KIFC

Double adaptor with solvent weld socket df , solvent weld spigot dm and BSP threaded male end R

$dm \times df \times R$	PN	K	L_1	L_f	L_m	Z	g	Code
20 x 16 x 3/8"	16	22	11.4	14	16	20	7	KIFC020016038
25 x 20 x 1/2"	16	28	15	16	19	25	13	KIFC025020012
32 x 25 x 3/4"	16	34	16.3	19	22	27	23	KIFC032025034
40 x 32 x 1"	16	42	19.1	22	26	30.5	38	KIFC040032100
50 x 40 x 1" 1/4	16	52	21.4	26	31	35	65	KIFC050040114
63 x 50 x 1" 1/2	16	65	21.4	31	38	35	113	KIFC063050112
75 x 63 x 2"	16	75	25.7	38	44	41	158	KIFC075063200

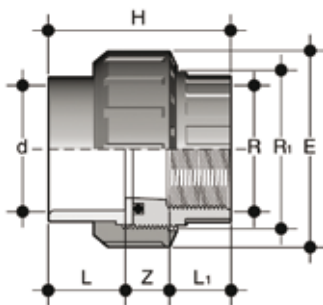

BIFC

Union with solvent weld socket d and BSP threaded female end R with O-ring in EPDM

$d \times R$	R_1	PN	E	H	L	L_1	Z	g	Code
16 x 3/8"	3/4"	16	33	41	14	11.4	15.6	25	BIFC016038E
20 x 1/2"	1"	16	41	45	16	15	14	40	BIFC020012E
25 x 3/4"	1" 1/4	16	51	51	19	16.3	15.7	68	BIFC025034E
32 x 1"	1" 1/2	16	58	57	22	19.1	15.9	93	BIFC032100E
40 x 1" 1/4	2"	16	72	67	26	21.4	19.6	158	BIFC040114E
50 x 1" 1/2	2" 1/4	16	79	72	31	21.4	19.6	193	BIFC050112E
63 x 2"	2" 3/4	16	98	88	38	25.7	24	345	BIFC063200E

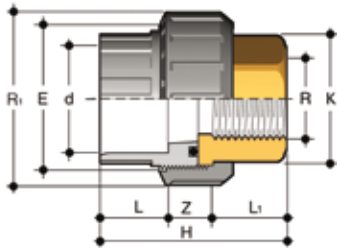

BIFOC

Adaptor union in PVC-C/brass with solvent weld socket d and BSP threaded brass female end R with O-Ring in EPDM

d x R	R ₁	PN	E	H	K	L	L ₁	Z	g	Code
16 x 3/8"	3/4"	16	33	45.5	20	14	13.5	18	55	BIFOC016038E
20 x 1/2"	1"	16	41	48.5	25	16	16.5	16	88.5	BIFOC020012E
25 x 3/4"	1 1/4"	16	50	54.5	32	19	18.5	17	165	BIFOC025034E
32 x 1"	1 1/2"	16	58	59.5	38	22	19.5	18	187	BIFOC032100E
40 x 1 1/4"	2"	16	72	68.5	48	26	21.5	21	379	BIFOC040114E
50 x 1 1/2"	2 1/4"	16	79	84.5	55	31	23	30.5	475	BIFOC100112E
63 x 2"	2 3/4"	16	98	94.5	69	38	27	29.5	837	BIFOC063200E

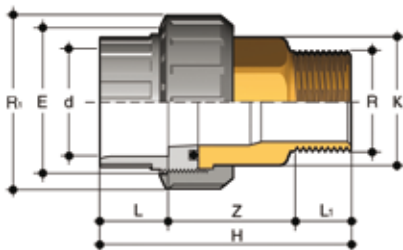

BIROC

Adaptor union in PVC-C/brass with solvent weld socket d and BSP threaded brass male end R with O-Ring in EPDM

d x R	R ₁	PN	E	H	K	L	L ₁	Z	g	Code
16 x 3/8"	3/4"	16	33	58.5	20	14	10.5	34	81	BIROC016038E
20 x 1/2"	1"	16	41	65	25	16	13.5	35.5	133.5	BIROC020012E
25 x 3/4"	1 1/4"	16	50	72.5	32	19	15	38.5	223	BIROC025034E
32 x 1"	1 1/2"	16	58	80	38	22	17.5	40.5	294	BIROC032100E
40 x 1 1/4"	2"	16	72	91	48	26	19.5	45.5	558	BIROC040114E
50 x 1 1/2"	2 1/4"	16	79	101	55	31	19.5	50.5	696	BIROC100112E
63 x 2"	2 3/4"	16	98	122.5	69	38	24	60.5	1196	BIROC063200E

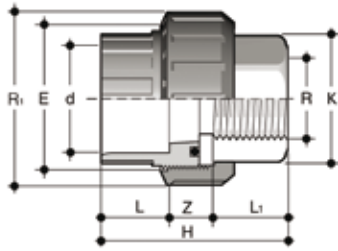

BIFXC

Adaptor union in PVC-C/STAINLESS steel with solvent weld socket d and BSP threaded STAINLESS steel female end R with O-Ring in EPDM or FPM

d x R	R ₁	PN	E	H	K	L	L ₁	Z	g	EPDM Code	FPM Code
16 x 3/8"	3/4"	16	33	45.5	20	14	13.5	18	52	BIFXC016038E	BIFXC016038F
20 x 1/2"	1"	16	41	48.5	25	16	16.5	16	83.5	BIFXC020012E	BIFXC020012F
25 x 3/4"	1 1/4"	16	50	54.5	32	19	18.5	17	156	BIFXC025034E	BIFXC025034F
32 x 1"	1 1/2"	16	58	59.5	38	22	19.5	18	176	BIFXC032100E	BIFXC032100F
40 x 1 1/4"	2"	16	72	68.5	48	26	21.5	21	361	BIFXC040114E	BIFXC040114F
50 x 1 1/2"	2 1/4"	16	79	84.5	55	31	23	30.5	450	BIFXC100112E	BIFXC100112F
63 x 2"	2 3/4"	16	98	94.5	69	38	27	29.5	792	BIFXC063200E	BIFXC063200F

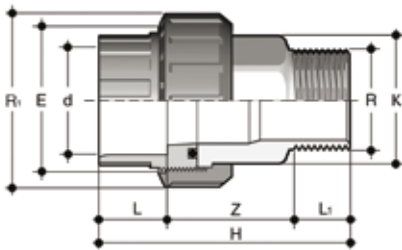

BIRXC

Adaptor union in PVC-C/STAINLESS steel with solvent weld socket d and BSP threaded STAINLESS steel male end R with O-Ring in EPDM or FPM

d x R	R ₁	PN	E	H	K	L	L ₁	Z	g	EPDM Code	FPM Code
16 x 3/8"	3/4"	16	33	58.5	20	14	10.5	34	76	BIRXC016038E	BIRXC016038F
20 x 1/2"	1"	16	41	65	25	16	13.5	35.5	125.5	BIRXC020012E	BIRXC020012F
25 x 3/4"	1 1/4"	16	50	72.5	32	19	15	38.5	219	BIRXC025034E	BIRXC025034F
32 x 1"	1 1/2"	16	58	80	38	22	17.5	40.5	275	BIRXC032100E	BIRXC032100F
40 x 1 1/4"	2"	16	72	91	48	26	19.5	45.5	524	BIRXC040114E	BIRXC040114F
50 x 1 1/2"	2 1/4"	16	79	101	55	31	19.5	50.5	654	BIRXC100112E	BIRXC100112F
63 x 2"	2 3/4"	16	98	122.5	69	38	24	60.5	1124	BIRXC063200E	BIRXC063200F

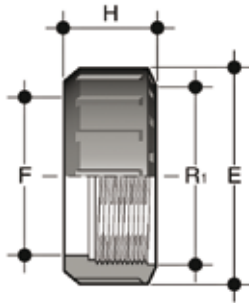

EFC

Union nut with BSP thread for union types BIC, BIFC, BFC, BLC, BIRC, BIFOC, BIROC, BIFXC, BIRXC.

R ₁	d BIC	PN	E	F	H	g	Code
3/4"	16	16	33	22	21	9	EFC034
1"	20	16	41	28	22	13	EFC100
1"1/4	25	16	50	36	25	22	EFC114
1"1/2	32	16	58	42	27	30	EFC112
2"	40	16	72	53	30	50	EFC200
2"1/4	50	16	79	59	34	68	EFC214
2"3/4	63	16	98	74	38	120	EFC234

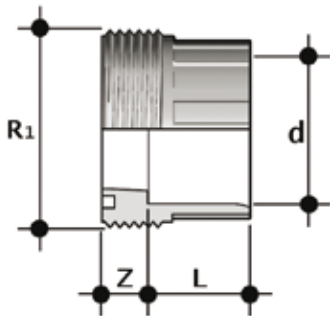

F/BIC

Union bush for solvent welding, metric series

d	R ₁	PN	L	Z	g	Code
16	3/4"	16	14	10	9	FBIC016
20	1"	16	16	10	13	FBIC020
25	1"1/4	16	19	10	25	FBIC025
32	1"1/2	16	22	10	31	FBIC032
40	2"	16	26	12	58	FBIC040
50	2"1/4	16	31	14	63	FBIC050
63	2"3/4	16	38	19	119	FBIC063

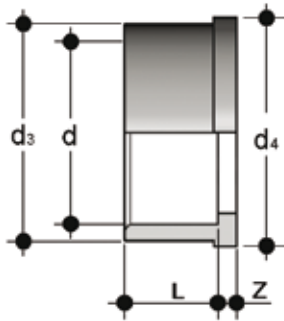

Q/BIC

Union end for solvent welding, metric series

d	PN	d ₃	d ₄	L	Z	g	Code
16	16	22	24	14	3	5	QBIC016
20	16	27.5	30.1	16	3	10	QBIC020
25	16	36	38.8	19	3	16	QBIC025
32	16	41.5	44.7	22	3	23	QBIC032
40	16	53	56.5	26	3	40	QBIC040
50	16	59	62.6	31	3	44	QBIC050
63	16	74	78.4	38	3	82	QBIC063

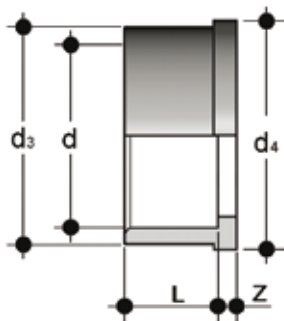

Q/BAC

Union end for solvent welding, ASTM series

d	PN	d ₃	d ₄	L	Z	g	Code
1/2"	16	27.5	30.1	22.7	3.5	17	QBAC012
3/4"	16	36	38.8	25.9	3.7	25	QBAC034
1"	16	41.5	44.7	29.2	3	36	QBAC100
1"1/4	16	53	56.5	32	5	63	QBAC114
1"1/2	16	59	62.6	35	5	86	QBAC112
2"	16	74	78.4	38.5	5.5	143	QBAC200

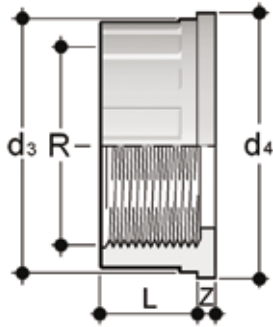

Q/BFC

Union end with BSP female thread

R	PN	d_3	d_4	L	Z	g	Code
3/8"	16	22	24	11.4	4.5	5	QBFC038
1/2"	16	27.5	30.1	15	5	9	QBFC012
3/4"	16	36	38.8	16.3	5	17	QBFC034
1"	16	41.5	44.7	19.1	5.5	23	QBFC100
1"1/4	16	53	56.5	21.4	5.5	37	QBFC114
1"1/2	16	59	62.6	21.4	5.5	44	QBFC112
2"	16	74	78.4	25.7	5.5	79	QBFC200

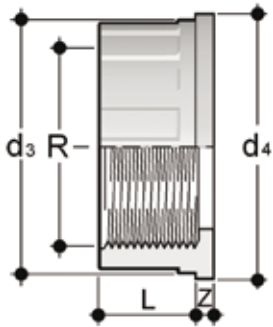

Q/BNC

Union end with NPT female thread

R	PN	d_3	d_4	L	Z	g	Code
3/8"	16	22	24	12.7	6.3	11	QBNC038
1/2"	16	27.5	30.1	17.8	5.2	17	QBNC012
3/4"	16	36	38.8	18	5.2	22	QBNC034
1"	16	41.5	44.7	22.6	5.7	33	QBNC100
1"1/4	16	53	56.5	25.1	7.3	61	QBNC114
1"1/2	16	59	62.6	24.7	7	77	QBNC112
2"	16	74	78.4	29.6	7.8	127	QBNC200

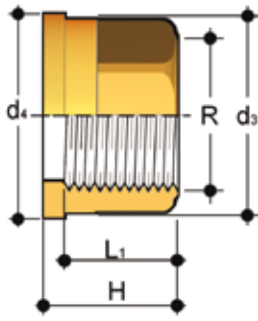

Q/BFO

Union end in brass with female BSP thread

R	d ₃	d ₄	H	L ₁	g	Code
3/8"	22	24	21.5	13.5	38	QBFO038
1/2"	27.5	30.1	22.5	16.5	60	QBFO012
3/4"	36	38.8	25.5	18.5	116	QBFO034
1"	41.5	44.7	27.5	19.5	144	QBFO100
1 1/4"	53	56.5	30.5	21.5	260	QBFO114
1 1/2"	59	62.6	33.5	23	325	QBFO112
2"	74	78.4	38.5	27	578	QBFO200

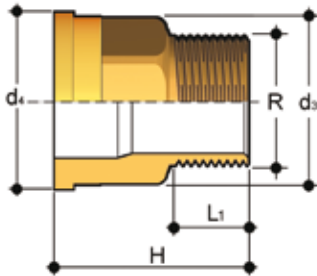

Q/BRO

Union end in brass with male BSP thread

R	d ₃	d ₄	H	L ₁	g	Code
3/8"	22	24	34.5	10.5	64	QBRO038
1/2"	27.5	30.1	39	13.5	105	QBRO012
3/4"	36	38.8	43.5	15	184	QBRO034
1"	41.5	44.7	48	17.5	251	QBRO100
1 1/4"	53	56.5	53	19.5	437	QBRO114
1 1/2"	59	62.6	56	19.5	545	QBRO112
2"	74	78.4	65.5	24	937	QBRO200

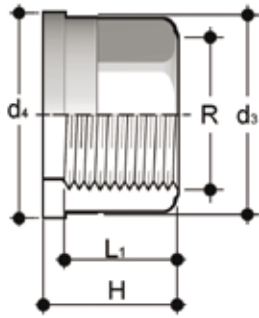

Q/BFX

Union end in A316L stainless steel with female BSP thread

R	d ₃	d ₄	H	L ₁	g	Code
3/8"	22	24	21.5	13.5	34	QBFX038
1/2"	27.5	30.1	22.5	16.5	54	QBFX012
3/4"	36	38.8	25.5	18.5	104	QBFX034
1"	41.5	44.7	27.5	19.5	130	QBFX100
1 1/4"	53	56.5	30.5	21.5	234	QBFX114
1 1/2"	59	62.6	33.5	23	293	QBFX112
2"	74	78.4	38.5	27	520	QBFX200

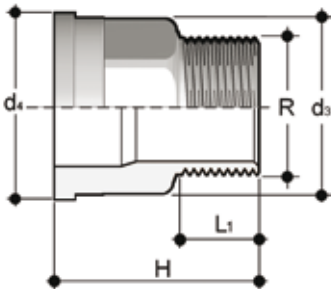

Q/BRX

Union end in A316L stainless steel with male BSP thread

R	d ₃	d ₄	H	L ₁	g	Code
3/8"	22	24	34.5	10.5	58	QBRX038
1/2"	27.5	30.1	39	13.5	95	QBRX012
3/4"	36	38.8	43.5	15	166	QBRX034
1"	41.5	44.7	48	17.5	226	QBRX100
1 1/4"	53	56.5	53	19.5	393	QBRX114
1 1/2"	59	62.6	56	19.5	491	QBRX112
2"	74	78.4	65.5	24	843	QBRX200

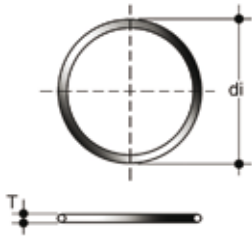

O-Ring

O-Ring for union types BIC, BIFC, BIFOC, BIFXC, BIRXC

Union d	C	di	T	EPDM Code	FPM Code
16	3062	15.54	2.62	OR3062E	OR3062F
20	4081	20.22	3.53	OR4081E	OR4081F
25	4112	28.17	3.53	OR4112E	OR4112F
32	4131	32.93	3.53	OR4131E	OR4131F
40	6162	40.65	5.34	OR6162E	OR6162F
50	6187	47	5.34	OR6187E	OR6187F
63	6237	59.69	5.34	OR6237E	OR6237F
75	6300	75.57	5.34	OR6300E	OR6300F
90	6362	91.45	5.34	OR6362E	OR6362F
110	6450	113.67	5.34	OR6450E	OR6450F