

# ROBUST: The name speaks for itself.

Very compact design with enormous power. Thanks to efficient sound insulation the ROBUST high pressure blower is very quiet. It can be installed in all orientations and is virtually indestructible even under extreme conditions and continuous operation.

High pressure blower

## ROBUST



### Technical data ROBUST

Design: Side Channal Blower

Frequency	Hz	50	60
Air flow (20 °C)	l/min	1200	1300
Static pressure	kPa	8.0	10.5
Max. ambient temperature	°C	60	60
Max. air inlet temperature	°C	60	60
Noise emission level	dB(A)	62	62
Environmental protection (IEC 60529)		IP 54	IP 54
Outside diameter air inlet	mm	∅ 38	∅ 38
Outside diameter air outlet	mm	∅ 38	∅ 38
Weight	kg	8.0	8.0
Conformity mark		CE	CE
Protection class I		⊕	⊕

Can be controlled with FC (page 57), 20 – 60 Hz

Installation dimensions  
in mm

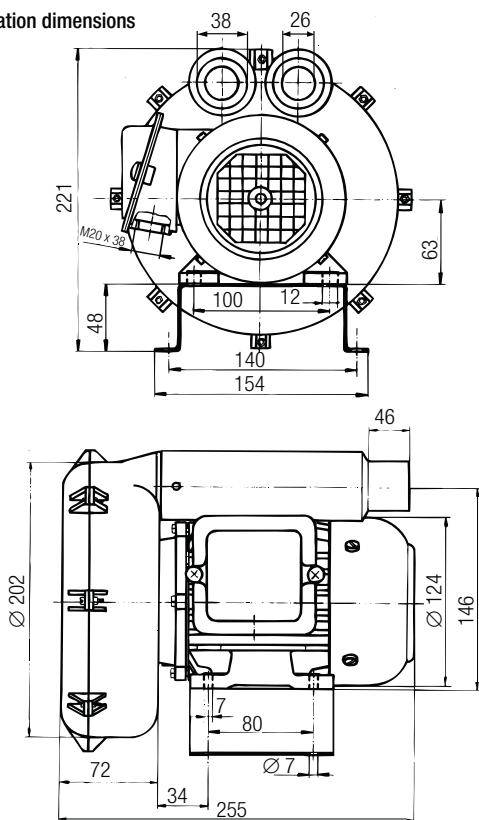

Voltage	V ~ 50 Hz	1 x 120	1 x 230	3 x 230 / 400
	V ~ 60 Hz			3 x 440 – 480
Power consumption	W	250	250	250
<b>Without cable</b>	<b>Order no.</b>	<b>103.434</b>		<b>103.429</b>
<b>3 m cable / Euro plug</b>	<b>Order no.</b>		<b>103.432</b>	

Additional versions available on request

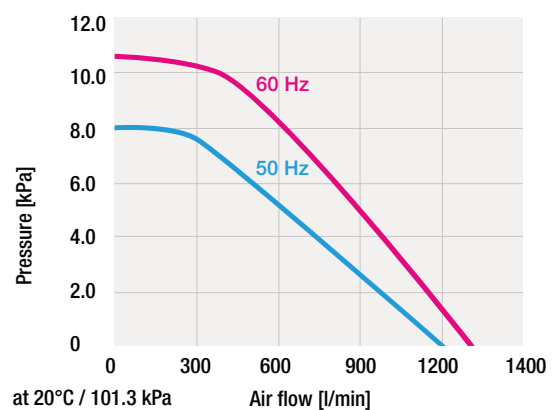

at 20°C / 101.3 kPa







Air flow [l/min]

Accessories 

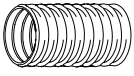
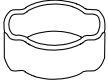
The combination of blow-off nozzles and blowers allows fast and efficient drying of beverage bottles.

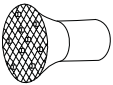

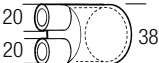
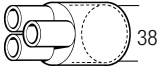
## Accessories ROBUST (Ø 38 mm)

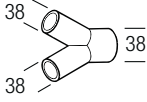
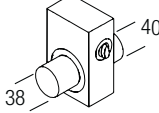
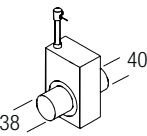
	<b>113.859</b> PVC air hose Ø 14mm <b>107.350</b> PVC air hose Ø 19 mm <b>107.286</b> PVC air hose Ø 38 mm
	<b>107.290</b> Hose clip for Ø 19 mm air hose
	<b>107.242</b> Closing cap Ø 19 mm, attachable to hose connection adaptor 107.298
	<b>107.354</b> Stainless steel filter, push-fit on air intake
	<b>108.623</b> Motor capacitor 230 V~ <b>104.017</b> Motor capacitor 120 V~
	<b>107.298</b> Hose connection adaptor, push-fit on ROBUST blower and adapter 107.293 for hose connection
	<b>107.281</b> Hose connection adaptor (Ø 38 mm), 3 outputs, each 14 mm
	<b>107.287</b> Hose clip for air hose Ø 38 mm and Ø 60 mm
	<b>107.241</b> Closing cap Ø 38 mm, attachable to hose connection adaptor 107.292 and 107.293
	<b>107.293</b> Hose connection adaptor, push-fit
	<b>108.755</b> Hand operated air flow adjuster and on/off switch. Size 214 x 88 x 133 mm
	<b>107.299</b> Air flow off/on switch The air flow is interrupted on command (pneumatic 500 kPa) to the heaters. Size 214 x 88 x 133 mm